



Os reatores são os principais responsáveis pela partida e funcionamento das lâmpadas. Sem os reatores, elas simplesmente não acendem. Sua função é proporcionar partida firme e estabilizada à lâmpada, sem produzir cintilação (efeito pisca-pisca), e atua como limitador da corrente elétrica.

- Linha profissional e linha standard
- Excelente eficiência de energia
- Reatores para todos os tipos de aplicações
- Alto fator e baixo fator de potência

TLS PROFISSIONAL 220V

Duplo **Simplex**
2x14/13W **1x14/13W**
2x28/25W **1x28/25W**



CÓDIGO	MODELO	TENSÃO	FATOR POTENCIA 220V	THD	(kHz)	Pt (W)	CORRENTE TOTAL Amp 220V	FEF.	PESO (Kg) UNITARIO	PESO (Kg) COLETIVA
F109314	2x28W	220V	0,99	<10%	48	59	0,27	1,69	0,110	1,182
-	2x25W	220V	0,99	<10%	48	57	0,26	1,75	-	-
-	2x14W	220V	0,99	<10%	48	33	0,15	3,03	-	-
-	2x13W	220V	0,99	<10%	48	30	0,14	3,33	-	-
-	1x28W	220V	0,99	<10%	48	31	0,14	3,23	-	-
-	1x25W	220V	0,99	<10%	48	30	0,14	3,33	-	-
-	1x14W	220V	0,97	<15%	48	18	0,09	5,56	-	-
-	1x13W	220V	0,97	<15%	48	17	0,08	5,88	-	-

- 50.000H
- ALTO FATOR DE POTÊNCIA
- 220V - 50/60HZ
- LINHA PROFISSIONAL

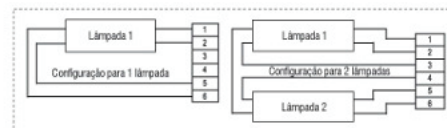

FLUXO LUMINOSO CONSTANTE: 1.0 TEMP. AMBIENTE: 0°C a +50°C CAIXA COM 10 PEÇAS
 TEMP. DA CARÇAÇA: 75°C PARTIDA RÁPIDA PROGRAMADA

TLS PROFISSIONAL 220V

Duplo **Simplex**
2x54/50W **1x54/50W**



CÓDIGO	MODELO	TENSÃO	FATOR POTENCIA 220V	THD	(kHz)	Pt (W)	CORRENTE TOTAL Amp 220V	FEF.	PESO (Kg) UNITARIO	PESO (Kg) COLETIVA
F109313	2x54W	220V	0,99	<10%	50	108	0,49	0,93	0,134	1,422
-	2x50W	220V	0,99	<10%	50	100	0,46	1,00	-	-
-	1x54W	220V	0,99	<10%	50	58	0,27	1,72	-	-
-	1x50W	220V	0,99	<10%	50	56	0,26	1,79	-	-

- 50.000H
- ALTO FATOR DE POTÊNCIA
- 220V - 50/60HZ
- LINHA PROFISSIONAL

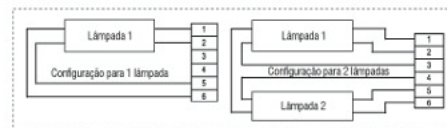

FLUXO LUMINOSO CONSTANTE: 1.0 TEMP. AMBIENTE: 0°C a +50°C CAIXA COM 10 PEÇAS
 TEMP. DA CARÇAÇA: 75°C PARTIDA RÁPIDA PROGRAMADA

ADVANCED EX - T5 220V

Duplo 2x54/50W
2x28/25/14W

Simples 1x54/50W
1x28/25/14W



C243 mm x A29 mm x L37 mm
*334 mm x 37 mm x 35,5 mm



CÓDIGO	MODELO	TENSÃO	FATOR POTÊNCIA 127V - 220V	THD	CORRENTE TOTAL Amp 220V	F.E.F.	PESO (Kg) UNITÁRIO	PESO (Kg) COLETIVA
F107385*	2x54 / 50W	220V	1,00	<10%	0,500	0,87	0,2580	2,700
F107387	2x28/25W 2x14W	220V	1,00	<10%	0,280 0,150	1,64 3,12	0,1888	1,972
F107393	1x54/50W	220V	1,00	<10%	0,260	1,72	0,1662	1,746
F107398	1x28/25W 1x14W	220V	1,00	<10%	0,140 0,090	3,33 5,88	0,1656	1,74

FLUXO LUMINOSO CONSTANTE: 1.0
TEMP. DA CARÇAÇA: 65°C

TEMP. AMBIENTE: -10°C a +50°C
PARTIDA RÁPIDA (Soft Start)

CAIXA COM 10 PEÇAS
THD <10%

- 50.000H
- ALTO FATOR DE POTÊNCIA
- MONO 220V - 50/60HZ
- LINHA PROFISSIONAL T5

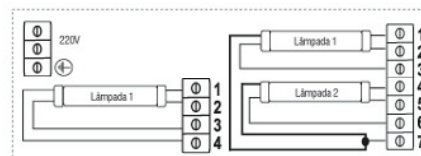

ADVANCED EX - T8 220V

Duplo 2x32/16W

Simples 1x32/16W



C243 mm x A29 mm x L37 mm



CÓDIGO	MODELO	LÂMPADA	TENSÃO	FATOR POTÊNCIA 220V	THD	CORRENTE TOTAL Amp 220V	F.E.F.	PESO (Kg) UNITÁRIO	PESO (Kg) COLETIVA
F107374	2x32W 2x16W	T8	220V	1,00	<10%	0,300 0,160	1,53 3,03	0,1858	1,942
F107380	1x32W 1x16W	T8	220V	1,00	<10%	0,170 0,095	2,78 5,25	0,1634	1,718

FLUXO LUMINOSO CONSTANTE: 1.0
TEMP. DA CARÇAÇA: 65°C

TEMP. AMBIENTE: -10°C a +50°C
PARTIDA RÁPIDA (Soft Start)

CAIXA COM 10 PEÇAS
THD <10%

- 50.000H
- ALTO FATOR DE POTÊNCIA
- MONO 220V - 50/60HZ
- LINHA PROFISSIONAL T8

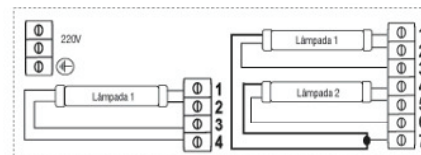

MASTER - T5 MULTIVOLT

Duplo 2x28/25/14W

Simples 1x28/25/14W
1x54/50W



C243 mm x A29 mm x L37 mm



CÓDIGO	MODELO	TENSÃO	FATOR POTÊNCIA 127V - 220V	THD	CORRENTE TOTAL Amp 127V	CORRENTE TOTAL Amp 220V	F.E.F.	PESO (Kg) UNITÁRIO	PESO (Kg) COLETIVA
F107440	2x28/25W 2x14W	Multivolt	1,00	<10%	0,480 0,260	0,280 0,150	1,64 3,12	0,1888	1,972
F107438	1x54 / 50W	Multivolt	1,00	<10%	0,470	0,260	1,72	0,1662	1,746
F107434	1x28/25W 1x14W	Multivolt	1,00	<10%	0,230 0,130	0,140 0,090	3,33 5,88	0,1662	1,74

FLUXO LUMINOSO CONSTANTE: 1.0
TEMP. DA CARÇAÇA: 65°C

TEMP. AMBIENTE: -10°C a +50°C
PARTIDA RÁPIDA (Soft Start)

CAIXA COM 10 PEÇAS
THD <10%

- 50.000H
- ALTO FATOR DE POTÊNCIA
- MULTIVOLT 127V/220V - 50/60HZ
- LINHA PROFISSIONAL T5

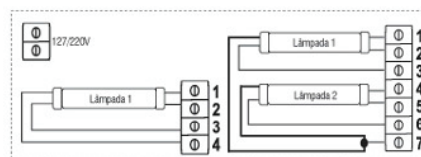

MASTER - T8 MULTIVOLT

Duplo **Simplex**
2x32/16W **1x32/16W**

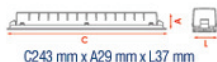

CÓDIGO	MODELO	LÂMPADA	TENSÃO	FATOR POTÊNCIA 127V - 220V	THD	CORRENTE TOTAL Amp 127V	CORRENTE TOTAL Amp 220V	EEF.	PESO (Kg) UNITÁRIO	PESO (Kg) COLETIVA
F107441	2x32W 2x16W	T8	Multivolt	1,00	<10%	0.520 0.260	0.300 0.160	1.53 - 3.03	0.1858	1.942
F107435	1x32W 1x16W	T8	Multivolt	1,00	<10%	0.290 0.150	0.170 0.095	2.78 - 5.25	0.1634	1.718

FLUXO LUMINOSO CONSTANTE: 1.0
 TEMP. DA CARÇAÇA: 65°C

TEMP. AMBIENTE: -10°C a +50°C
 PARTIDA RÁPIDA (Soft Start)

CAIXA COM 10 PEÇAS
 THD <10%

- 50.000H
- ALTO FATOR DE POTÊNCIA
- MULTIVOLT 127V/220V - 50/60HZ
- LINHA PROFESSIONAL T8/T10/T12

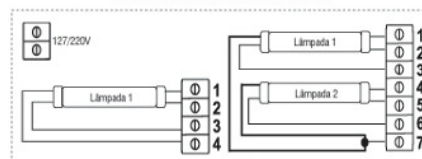

SYSTEM - T5

Duplo **Simplex**
2x14W **1x14W**
2x28/25W **1x28/25W**

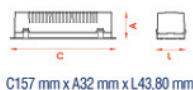

CÓDIGO	MODELO	TENSÃO	FATOR POTÊNCIA 127V - 220V	THD	CORRENTE TOTAL Amp 127V	CORRENTE TOTAL Amp 220V	EEF.	PESO (Kg) UNITÁRIO	PESO (Kg) COLETIVA
F107360	1x14W	127	0.99	10%	0,140	-	5.29	0.1408	3.0500
F107361	1x28 / 25W	127	0.99	10%	0,250	-	2.90	0.1489	3.1500
F107359	2x14W	127	0.99	10%	0,260	-	2.73	0.1723	3.6000
F107345	2x28 / 25W	127	0.99	10%	0,460	-	1.58	0.1992	4.1500
F107356	1x14W	220	0.99	10%	-	0,077	5.29	0.1401	2.9500
F107357	1x28 / 25W	220	0.99	10%	-	0,138	2.90	0.1491	3.1500
F107355	2x14W	220	0.99	10%	-	0,160	2.72	0.1691	3.5500
F107346	2x28 / 25W	220	0.99	10%	-	0,260	1.58	0.1994	4.1000

FLUXO LUMINOSO: 0.90
 TEMP. DA CARÇAÇA: 60°C

TEMP. AMBIENTE: 10°C a 50°C
 PARTIDA RÁPIDA (Soft Start)

CAIXA COM 20 PEÇAS

- 25.000H
- ALTO FATOR DE POTÊNCIA
- MONO 127V OU 220V - 50/60HZ
- LINHA STANDARD T5

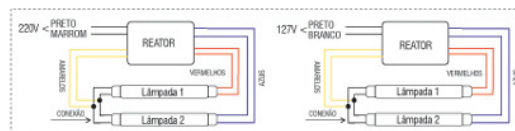

HTS

Simplex
1x110/85W
1x65/58W

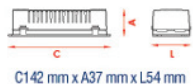

CÓDIGO	MODELO	LÂMPADA	TENSÃO	FATOR POTÊNCIA 127V - 220V	CORRENTE TOTAL Amp 127V	CORRENTE TOTAL Amp 220V	THD	EEF.	PESO (Kg) UNITÁRIO	PESO (Kg) COLETIVA		
F107027	1x110W	T10 / T12	BIV	0.99	0.96	0.820	0.500	10%	25%	0.85	0.2353	4.8500
	1x85W	T12	BIV	0.99	0.96	0.660	0.400	10%	25%	0.85		
F107028	1x65/58W	T8/T10/T12	BIV	0.99	0.96	0.456	0.263	10%	25%	1.55	0.2350	4.8500
F109300	1x110	T10 / T12	220	0.96		0.263		25%	1.55	0.2350	4.8500	
	1x85W	T12	220	0.96		0.400		25%	0.85			

FLUXO LUMINOSO CONSTANTE: 0.90
 TEMP. DA CARÇAÇA: 65°C

TEMP. AMBIENTE: 10°C a 50°C
 PARTIDA INSTANTÂNEA

CAIXA COM 20 PEÇAS

- 25.000H
- ALTO FATOR DE POTÊNCIA
- BIVOLT 127/220V ou MONO 220V - 50/60HZ
- LINHA STANDARD T8/T10/T12

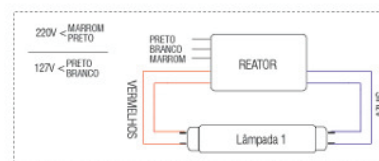

HTD

Duplo
2x110/85W

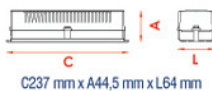

C237 mm x A44,5 mm x L64 mm



CÓDIGO	MODELO	LÂMPADA	TENSÃO	FATOR POTÊNCIA 127V - 220V	THD	CORRENTE TOTAL Amp 127V - 220V	FEF.	PESO (Kg) UNITARIO	PESO (Kg) COLETIVA
F107023	2x110/85W	T10/T12	127V	0.99C	10%	1.700	0.44	0.4477	4.6000

FLUXO LUMINOSO CONSTANTE: 0.90
TEMP. DA CARÇAÇA: 75°C

TEMP. AMBIENTE: 10°C a 50°C
PARTIDA INSTANTÂNEA

CAIXA COM 10 PEÇAS

- 25.000H
- ALTO FATOR DE POTÊNCIA
- MONO 127V - 50/60HZ
- LINHA STANDARD T10/T12

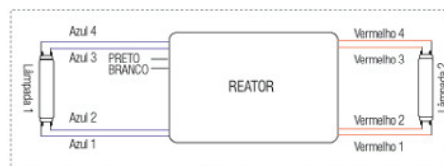

HTD

Duplo
2x110/85W
2x65/58W

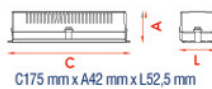

C175 mm x A42 mm x L52,5 mm



CÓDIGO	MODELO	LÂMPADA	TENSÃO	FATOR POTÊNCIA 127V - 220V	THD	CORRENTE TOTAL Amp 127V - 220V	FEF.	PESO (Kg) UNITARIO	PESO (Kg) COLETIVA
F106887	2x110/85W	T10/T12	220V	0.96C	20%	0.930	0.50	0.3557	3.7000
F106888	2x65/58W	T8/T10/T12	220V	0.96C	20%	0.598	0.71	0.3177	3.3500

FLUXO LUMINOSO CONSTANTE: 0.90
TEMP. DA CARÇAÇA: 75°C

TEMP. AMBIENTE: 10°C a 50°C
PARTIDA INSTANTÂNEA

CAIXA COM 10 PEÇAS

- 25.000H
- ALTO FATOR DE POTÊNCIA
- 220V - 50/60HZ
- LINHA STANDARD T8/T10/T12

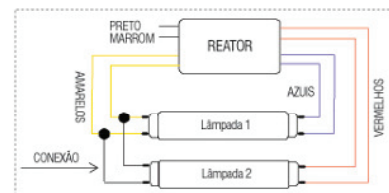

AF UNO SYSTEM

Duplo
2x32/30W



C157 x L33 x A43,8mm



CÓDIGO	MODELO	TENSÃO	FATOR POTÊNCIA 127V - 220V	CORRENTE TOTAL Amp 127V - 220V	THD	FEF.	PESO (Kg) UNITARIO	PESO (Kg) COLETIVA
F107320	2x32/30W	BIV	0.99 0.96	0.52 0.30	10%	20%	1.30 1.38	0.174 3.620

FLUXO LUMINOSO CONSTANTE: 0.90
TEMP. DA CARÇAÇA: 75°C

TEMP. AMBIENTE: 10°C a 50°C
PARTIDA INSTANTÂNEA

CAIXA COM 20 PEÇAS

- 25.000H
- ALTO FATOR DE POTÊNCIA
- BIVOLT 127/220V - 50/60HZ
- LINHA STANDARD T8/T10/T12

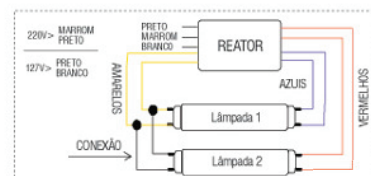

AF LUMI

Duplo
2x40/36W
2x32/30W

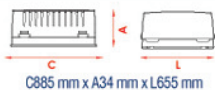

CÓDIGO	MODELO	LÂMPADA	TENSÃO	FAZOR POTENCIA 127V - 220V	CORRENTE TOTAL Amp 127V - 220V	FEF.	PESO (Kg) UNITARIO	PESO (Kg) COLETIVA
F109249	2x40/36W	T8/T10/T12	BIV	0.98/0.96	0.58 0.33	1.28	0,140	2,950
F109250	2x32/30W	T8	BIV	0.98/0.96	0.54 0.31	1.28	0,140	2,950

FLUXO LUMINOSO CONSTANTE: 0.90
TEMP. DA CARÇAÇA: 65°C

TEMP. AMBIENTE: 10°C a 50°C
PARTIDA INSTANTÂNEA

CAIXA COM 20 PEÇAS

- 25.000H
- ALTO FATOR DE POTÊNCIA
- BIVOLT 127/220V - 50/60HZ
- LINHA STANDARD T8/T10/T12

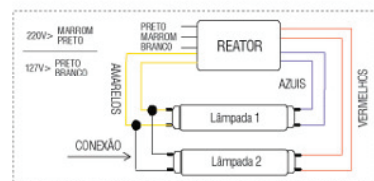

Tamanho reduzido, pode ser instalado em qualquer luminária

AF NANO

Duplo
2x20/18W
2x16W
2x15W

Simples
1x40/36W
1x32/30W
1x20/18W
1x16W

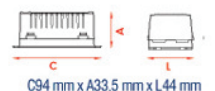

CÓDIGO	MODELO	LÂMPADA	TENSÃO	FAZOR POTENCIA 127V - 220V	THD	CORRENTE TOTAL Amp 127V - 220V	FEF.	PESO (Kg) UNITARIO	PESO (Kg) COLETIVA
F107259	1x40/36W	T8/T10/T12	BIV	0.99 0.96	10% 20%	0.312 0.175	2.36 2.50	0.0768	1.6000
F107264	2x20/18W	T8/T10/T12	BIV	0.99 0.96	10% 20%	0.300 0.165	2.43 2.57	0.0776	1,6500
F107265	2x16W	T8	BIV	0.99 0.96	10% 20%	0.240 0.140	2.81 2.81	0.0731	1,5500
F107266	1x32/30W	T8	BIV	0.99 0.96	10% 20%	0.240 0.140	2.81 2.81	0.0748	1,6000
F107328	1x16W	T8	BIV	0.99 0.96	10% 20%	0.145 0.080	4.28 4.73	0.0748	1,6000
F107329	1x20/18W	T8/T10/T12	BIV	0.99 0.96	10% 20%	0.175 0.090	5.00 5.29	0.0748	1,6000
F107330	2x15W	T8	BIV	0.99 0.96	10% 20%	0.240 0.135	3.00 3.21	0.0748	1,6000

FLUXO LUMINOSO CONSTANTE: 0.90
TEMP. DA CARÇAÇA: 65°C

TEMP. AMBIENTE: 10°C a 50°C
PARTIDA INSTANTÂNEA

CAIXA COM 20 PEÇAS

- 25.000H
- ALTO FATOR DE POTÊNCIA
- BIVOLT 127/220V - 50/60HZ
- LINHA STANDARD T8/T10/T12

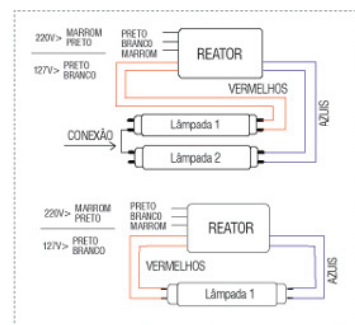

BF NANO

Simples
1x16/15W
1x20/18W

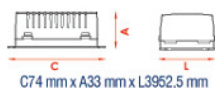

CÓDIGO	MODELO	LÂMPADA	TENSÃO	FAZOR POTENCIA 127V - 220V	CORRENTE TOTAL Amp 127V - 220V	FEF.	PESO (Kg) UNITARIO	PESO (Kg) COLETIVA
F106750	1x16/15W	T8	BIV	0.45C	0.25 0.13	5.98	0.0768	1.6000
F106752	1x20/18W	T8/T10/T12	BIV	0.45C	0.30 0.17	3.27	0.0776	1,6500

FLUXO LUMINOSO CONSTANTE: 0.90
TEMP. DA CARÇAÇA: 65°C

TEMP. AMBIENTE: 10°C a 50°C
PARTIDA INSTANTÂNEA

CAIXA COM 20 PEÇAS

- 25.000H
- Baixo Fator de Potência
- Bivolt 127/220V - 50/60Hz
- LINHA STANDARD T8/T10/T12

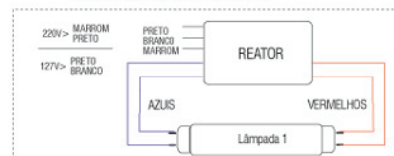

BF NANO

Simples
1x9W
1x18W

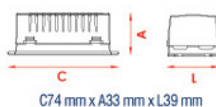

C74 mm x A33 mm x L39 mm



- 25.000H
- BAIXO FATOR DE POTÊNCIA
- BIVOLT 127/220V - 50/60HZ
- LINHA STANDARD COMPACTA

CÓDIGO	MODELO	TENSÃO	FATOR POTÊNCIA 127V - 220V	CORRENTE TOTAL Amp 127V - 220V	FEF.	PESO (Kg) UNITÁRIO	PESO (Kg) COLETIVA
F106760	1x9W	BIV	0.45C	0.15 0.08	5.34	0.0731	1,5500
F106751	1x18W	BIV	0.45C	0.26 0.14	2.97	0.0748	1,6000

FLUXO LUMINOSO CONSTANTE: 0.90
TEMP. DA CARÇAÇA: 65°C

TEMP. AMBIENTE: 10°C a 50°C
PARTIDA INSTANTÂNEA

CAIXA COM 20 PEÇAS

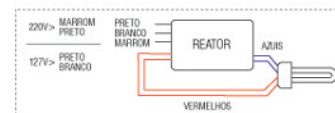

AF NANO

Simples
1x26W
1x36W

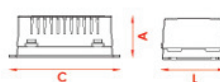

C94 mm x A33,5 mm x L44 mm



- 25.000H
- ALTO FATOR DE POTÊNCIA
- BIVOLT 127/220V - 50/60HZ
- LINHA STANDARD COMPACTA

CÓDIGO	MODELO	TENSÃO	FATOR POTÊNCIA 127V - 220V	CORRENTE TOTAL Amp 127V - 220V	FEF.	PESO (Kg) UNITÁRIO	PESO (Kg) COLETIVA
F107313	1x26W	BIV	0,99 0,96C	0,32 0,18	2,36 2,50	0,0723	1,5500
F107314	1x36W	BIV	0,99 0,96C	0,24 0,14	2,81 2,81	0,0748	1,6000

FLUXO LUMINOSO CONSTANTE: 0.90
TEMP. DA CARÇAÇA: 65°C

TEMP. AMBIENTE: 10°C a 50°C
PARTIDA INSTANTÂNEA

CAIXA COM 20 PEÇAS

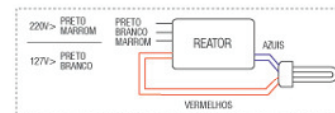

AF UNO SYSTEM

Duplo
2x36W

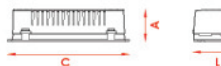

C157 mm x A32 mm x L43,80 mm



- 25.000H
- ALTO FATOR DE POTÊNCIA
- BIVOLT 127/220V - 50/60HZ
- LINHA STANDARD COMPACTA

CÓDIGO	MODELO	TENSÃO	FATOR POTÊNCIA 127V - 220V	CORRENTE TOTAL Amp 127V - 220V	THD	FEF.	PESO (Kg) UNITÁRIO	PESO (Kg) COLETIVA
F107327	2x36W	BIV	0.99 0.96C	0.55 0.318	10% 20%	1.28 1.28	0.1740	3.620

FLUXO LUMINOSO CONSTANTE: 0.90
TEMP. DA CARÇAÇA: 65°C

TEMP. AMBIENTE: 10°C a 50°C
PARTIDA INSTANTÂNEA

CAIXA COM 20 PEÇAS



AF LUX

Duplo
2x26W
2x18W
2x9W

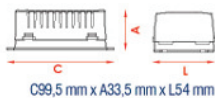

C99,5 mm x A33,5 mm x L54 mm



CÓDIGO	MODELO	TENSÃO	FATOR POTÊNCIA 127V - 220V	CORRENTE TOTAL Amp 127V - 220V	THD	FEF.	PESO (Kg) UNITÁRIO	PESO (Kg) COLETIVA
F107322	2x26W	BIV	0.98C 0.96C	0.39 0.22	10% 20%	1.91 1.91	0.1650	3.34
F107323	2x18W	BIV	0.98C 0.96C	0.33 0.19	10% 20%	2.25 2.25	0.1650	3.34
F107498	2x9W	BIV	0.98C 0.96C	0.15 0.07	10% 20%	1.91 1.91	0.1650	3.34

FLUXO LUMINOSO CONSTANTE: 0.90
TEMP. DA CARÇAÇA: 60°C

TEMP. AMBIENTE: 10°C a 50°C
PARTIDA INSTANTÂNEA

CAIXA COM 20 PEÇAS

- 25.000H
- ALTO FATOR DE POTÊNCIA
- BIVOLT 127/220V - 50/60HZ
- LINHA STANDARD COMPACTA

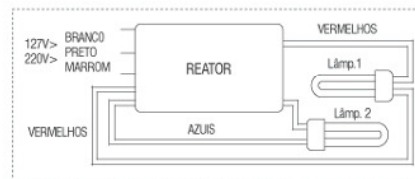

AF LUX

Duplo
1x22 + 1x32W

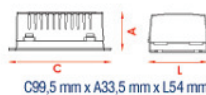

C99,5 mm x A33,5 mm x L54 mm



CÓDIGO	MODELO	TENSÃO	FATOR POTÊNCIA 127V - 220V	THD	CORRENTE TOTAL Amp 127V - 220V	FEF.	PESO (Kg) UNITÁRIO	PESO (Kg) COLETIVA
F107321	1x22+1x32W	BIV	0.98C 0.98C	10% 20%	0.435 0.238	1.67 1.80	0.1400	2.95

FLUXO LUMINOSO CONSTANTE: 0.90
TEMP. DA CARÇAÇA: 60°C

TEMP. AMBIENTE: 10°C a 50°C
PARTIDA INSTANTÂNEA

CAIXA COM 20 PEÇAS

- 25.000H
- ALTO FATOR DE POTÊNCIA
- BIVOLT 127/220V - 50/60HZ
- LINHA STANDARD CIRCULAR

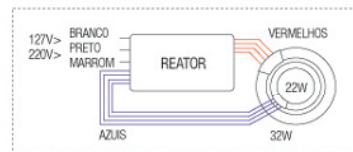

BF NANO

Simplex
1x22W

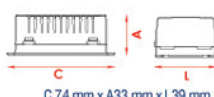

C 74 mm x A33 mm x L39 mm



CÓDIGO	MODELO	TENSÃO	FATOR POTÊNCIA 127V - 220V	CORRENTE TOTAL Amp 127V - 220V	FEF.	PESO (Kg) UNITÁRIO	PESO (Kg) COLETIVA
F106753	1x22W	BIV	0.54 0.49C	0.34 0.20	2.97	0.0723	1,5500

FLUXO LUMINOSO CONSTANTE: 0.90
TEMP. DA CARÇAÇA: 65°C

TEMP. AMBIENTE: 10°C a 50°C
PARTIDA INSTANTÂNEA

CAIXA COM 20 PEÇAS

- 25.000H
- BAIXO FATOR DE POTÊNCIA
- BIVOLT 127/220V - 50/60HZ
- LINHA STANDARD CIRCULAR

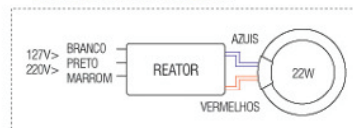

AF NANO

Simples
1x40W
1x32W

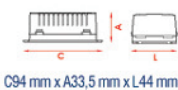

CÓDIGO	MODELO	TENSÃO	FATOR POTÊNCIA 127V - 220V	CORRENTE TOTAL Amp 127V - 220V	THD	FEF.	PESO (Kg) UNITÁRIO	PESO (Kg) COLETIVA
F107267	1x40W	BIV	0,99 0,96C	0,32 0,18	10% 20%	2,36 2,50	0,0723	1,5500
F107268	1x32W	BIV	0,99 0,96C	0,24 0,14	10% 20%	2,81 2,81	0,0748	1,6000

FLUXO LUMINOSO CONSTANTE: 0.90
TEMP. DA CARÇAÇA: 65°C

TEMP. AMBIENTE: 10°C a 50°C
PARTIDA INSTANTÂNEA

CAIXA COM 20 PEÇAS

- ALTO FATOR DE POTÊNCIA
- BIVOLT 127/220V - 50/60HZ
- LINHA STANDARD CIRCULAR 25.000H

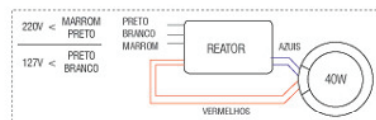

HALÓGENA

20W a 50W

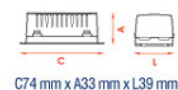

*Tensão de saída 12V / Carga máxima 50W

CÓDIGO	MODELO	TENSÃO	FATOR POTÊNCIA 127V - 220V	THD	CORRENTE TOTAL Amp 127V - 220V	FEF.	PESO (Kg) UNITÁRIO	PESO (Kg) COLETIVA
F103452	1x20 a 50W*	127	0,99	<10%	0,397	1,98	0,0640	0,8496
F103453	1x20 a 50W*	220	0,99	<10%	0,229	1,98	0,0652	0,8496

TEMP. DA CARÇAÇA: 75°C
PARTIDA INSTANTÂNEA

TEMP. AMBIENTE: 10°C a 50°C
THD <10%

CAIXA COM 12 PEÇAS

- DIMERIZÁVEL (DIMMER ECP)
- ENTRADA MONOVOLT 127V OU 220V - 50/60HZ

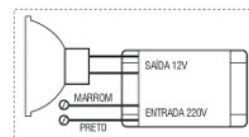

HALÓGENA

60W a 105W

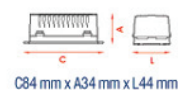

*Tensão de saída 12V / Carga máxima 105W

CÓDIGO	MODELO	TENSÃO	FATOR POTÊNCIA 127V - 220V	THD	CORRENTE TOTAL Amp 127V - 220V	FEF.	PESO (Kg) UNITÁRIO	PESO (Kg) COLETIVA
F107197	1x60 a 105W	127	0,99	<10%	0,700	0,95	0,1100	2,3500
F107198	1x60 a 105W	220	0,99	<10%	0,380	0,95	0,1100	2,3500

TEMP. DA CARÇAÇA: 75°C
PARTIDA INSTANTÂNEA

TEMP. AMBIENTE: 10°C a 50°C
THD <10%

CAIXA COM 20 PEÇAS

- DIMERIZÁVEL (DIMMER ECP)
- ENTRADA MONOVOLT 127V OU 220V - 50/60HZ

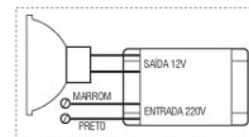

INLETOR

4W a 20W



CÓDIGO	MODELO	LÂMPADA	TENSÃO	CORRENTE TOTAL Amp	PESO (Kg) UNITÁRIO	PESO (Kg) COLETIVA
F106621	4W a 20W	TUBULAR	12Vdc	1,600	0,1500	3,1000
F106622	4W a 20W	TUBULAR	24Vdc	0,800	0,1510	3,1000

TEMP. DA CARÇAÇA: 75°C
PARTIDA INSTANTÂNEA

TEMP. AMBIENTE: 10°C a 50°C

CAIXA COM 20 PEÇAS

- MONOVOLT 12Vdc ou 24Vdc

